

G3 社会開発等4専攻 (801~950)

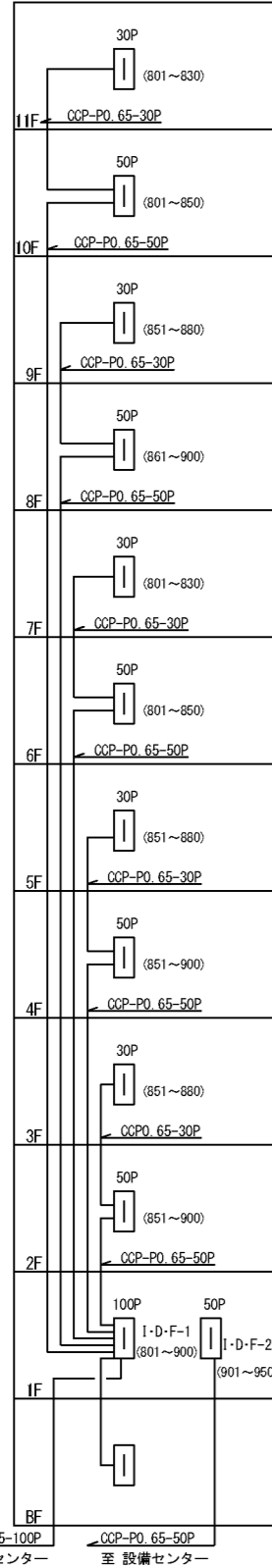

J2 総合研究棟 (1F~10F)

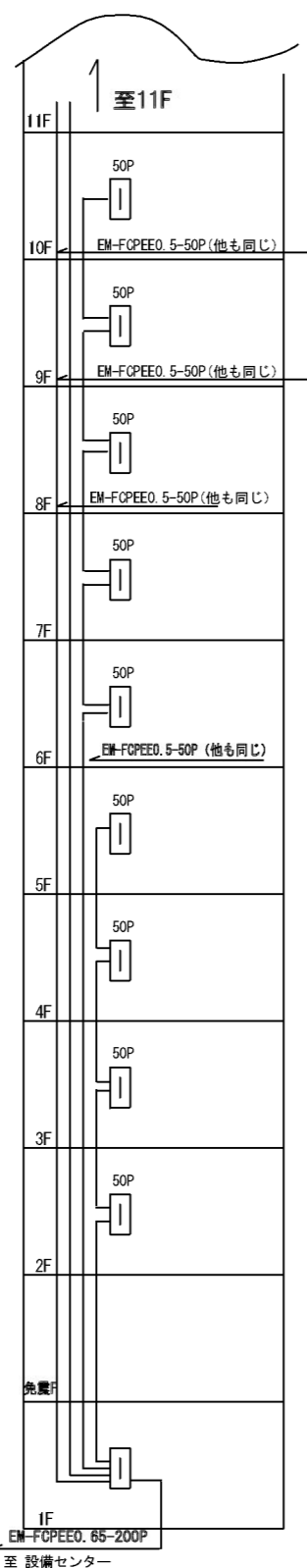

J2 総合研究棟 (11F~20F)

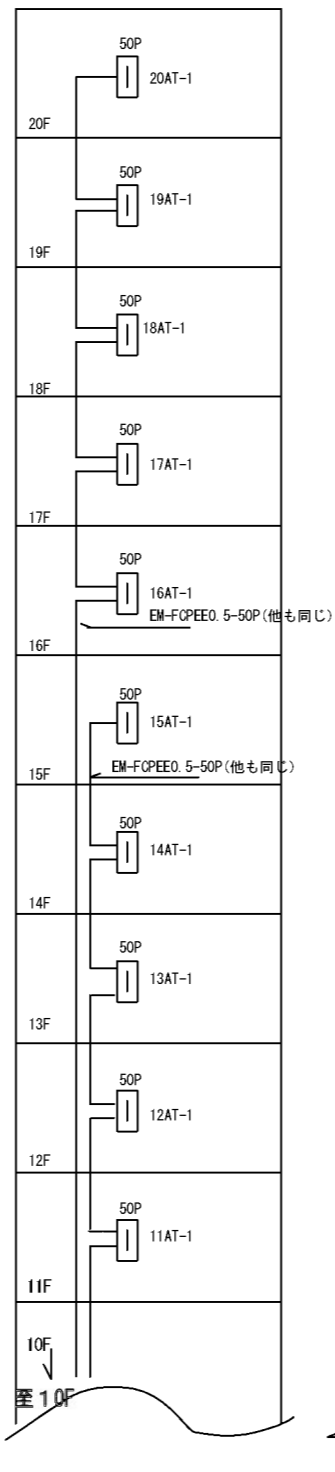

J1 合同1号館 (1001~1200)

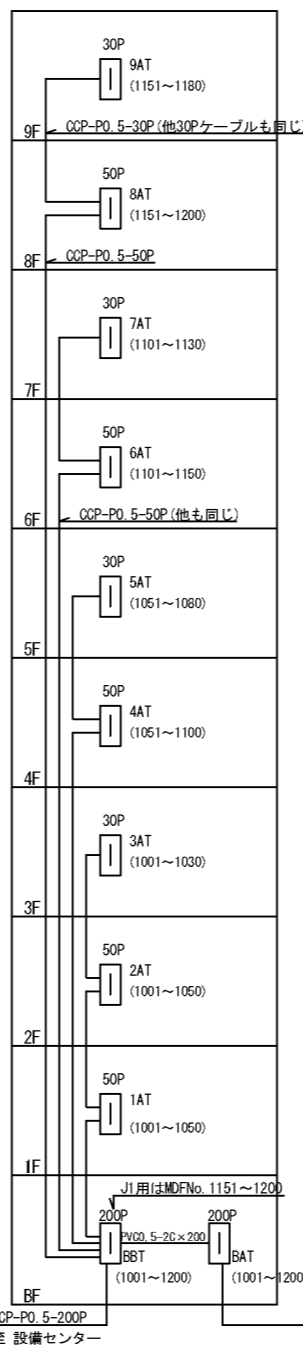

B1 生命理工学部棟 (1001~1200)

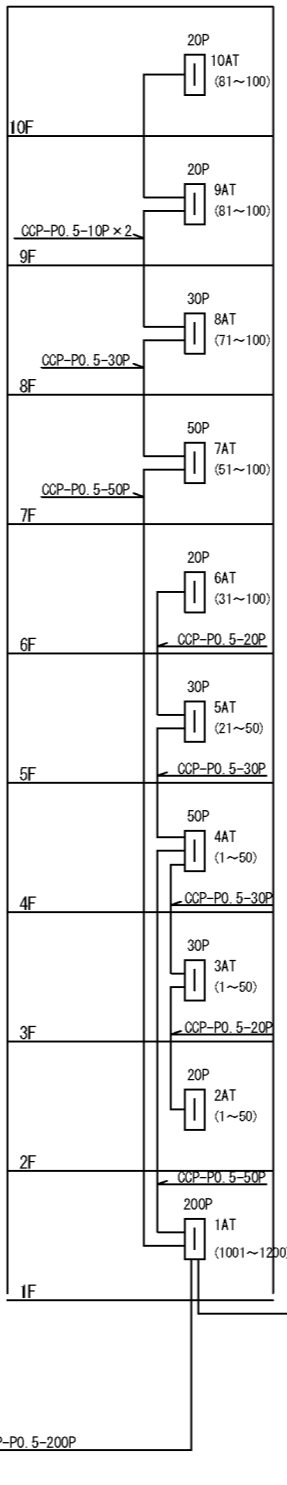

B2 生命理工学部棟 (1201~1400)

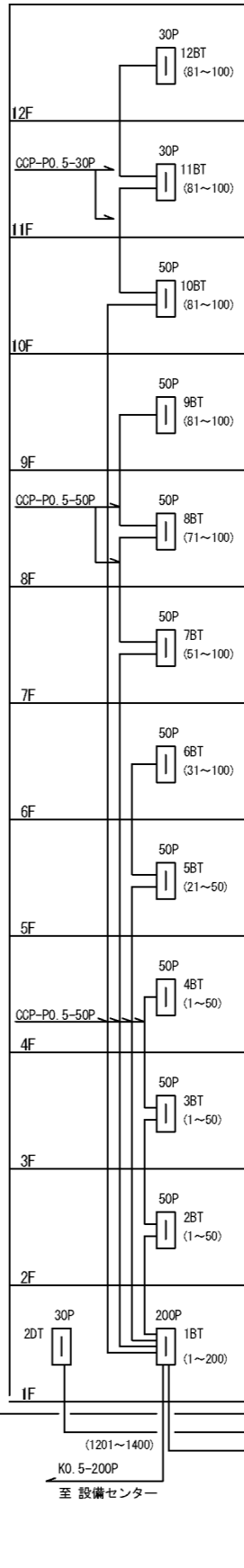

G4 共通管理棟 (701~750)

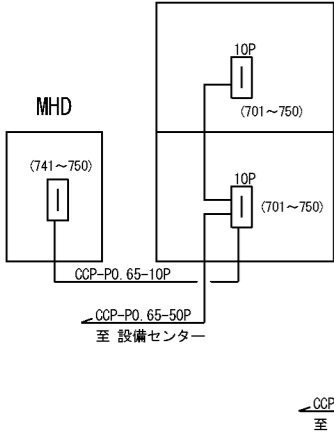

遺伝子実験施設

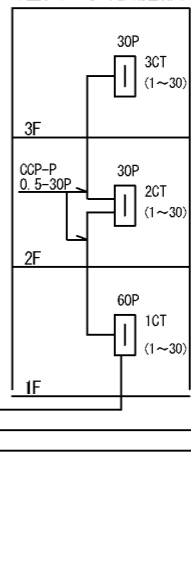

生物実験センター

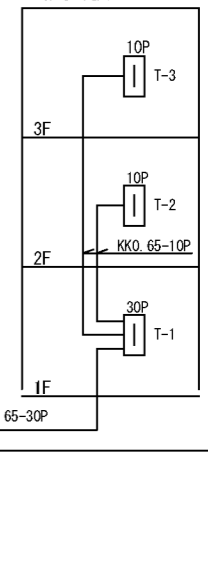

アイソトープ総合センター

